

# Clip Buddy

Patent 10,072,685

## Clip holding device for fixtures

Lever Open

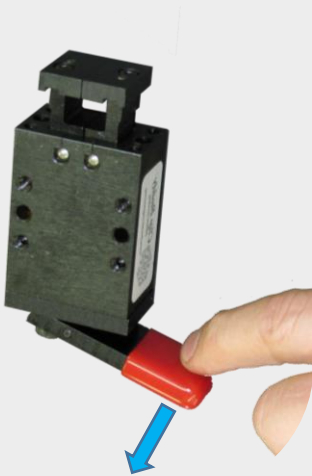

Lever Close

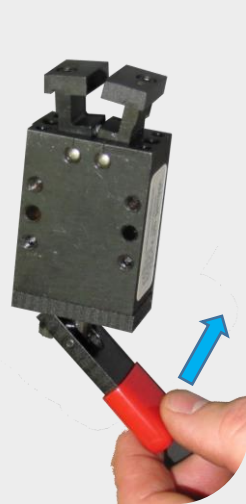

**Or**

Squeeze to Close



- Compact design
- Solid, snap-action closing
- Smooth, operator friendly motions
- Extensive Options:
  - 9 Jaw Options
  - 5 Mounting Brackets
  - 4 Manual Levers
  - Cable and Pneumatic Actuation Options

## Compare to conventional designs



**Clip Buddy**

Conventional Design

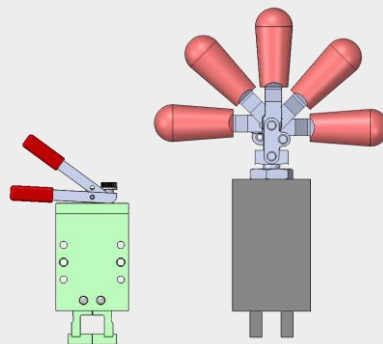

- Much smaller footprint
- Less access space required for actuation
- Extensive mounting and actuation options

- Opening and closing motions are smooth and compact
- Operator-friendly and reliable cable actuation system (optional)

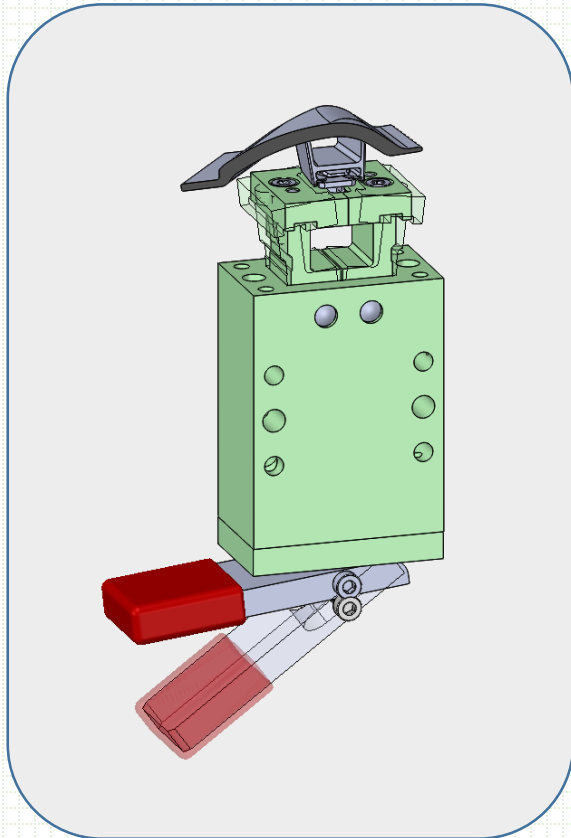

# ORDERING INFORMATION

# Clip Buddy

Patent 10,072,685

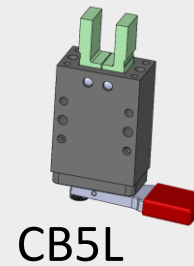
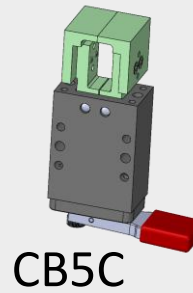
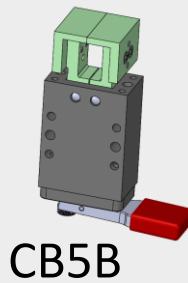
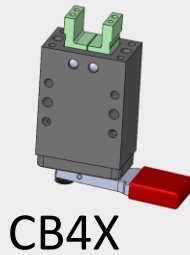
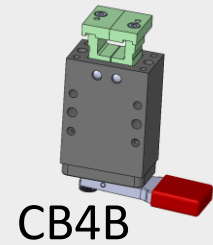
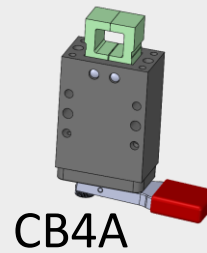
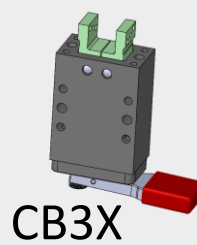
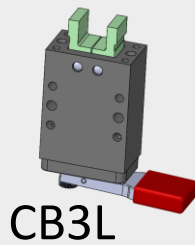
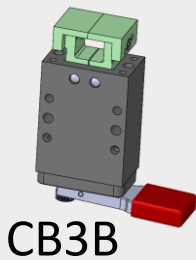

## Actuation Options

(short lever shown above is standard)

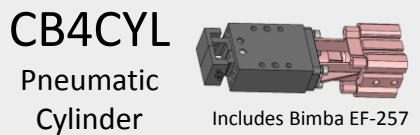
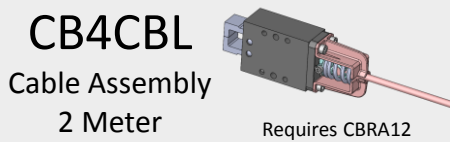
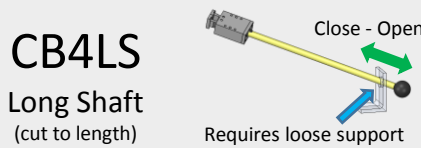
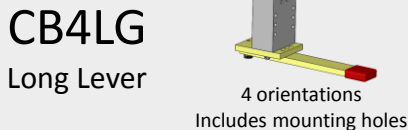
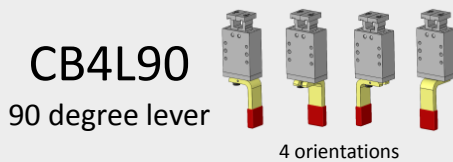

## Mounting Options

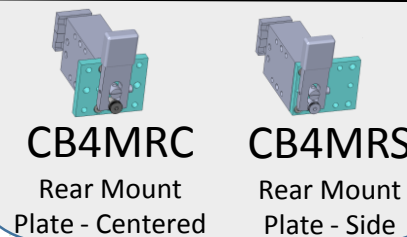
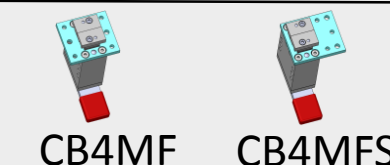
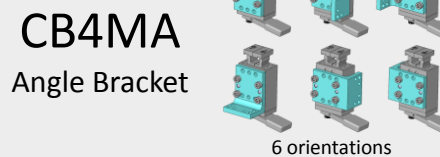
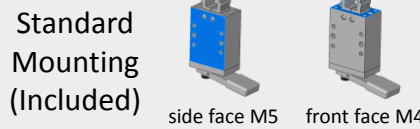

all optional mounting brackets have Ø5 dowel holes and M5 tapped holes

## Accessories



Smooth, operator-friendly actuation.  
Reliable operation, simple adjustment

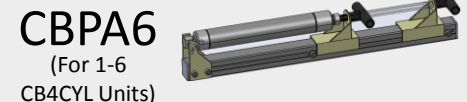

### Pneumatic Actuators

Onboard actuation for CB4CYL/CB4CYLM-equipped units.  
No air hookup, no high pinch force.

